

2 CHAINLINK FENCE W/NETTING ABOVE
SCALE: N15

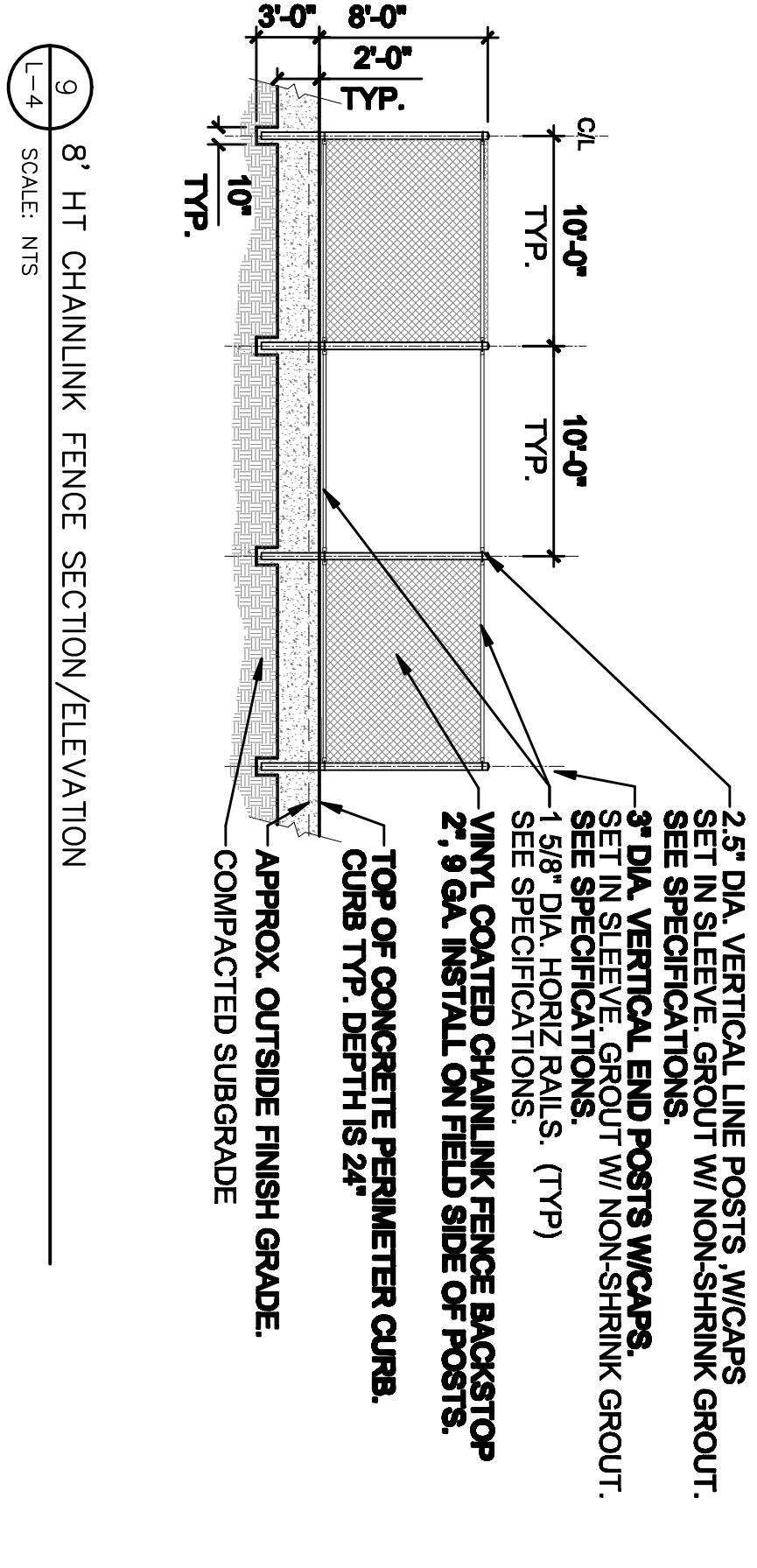

3 8' HT CHAINLINK FENCE SECTION/ELEVATION
SCALE: N15

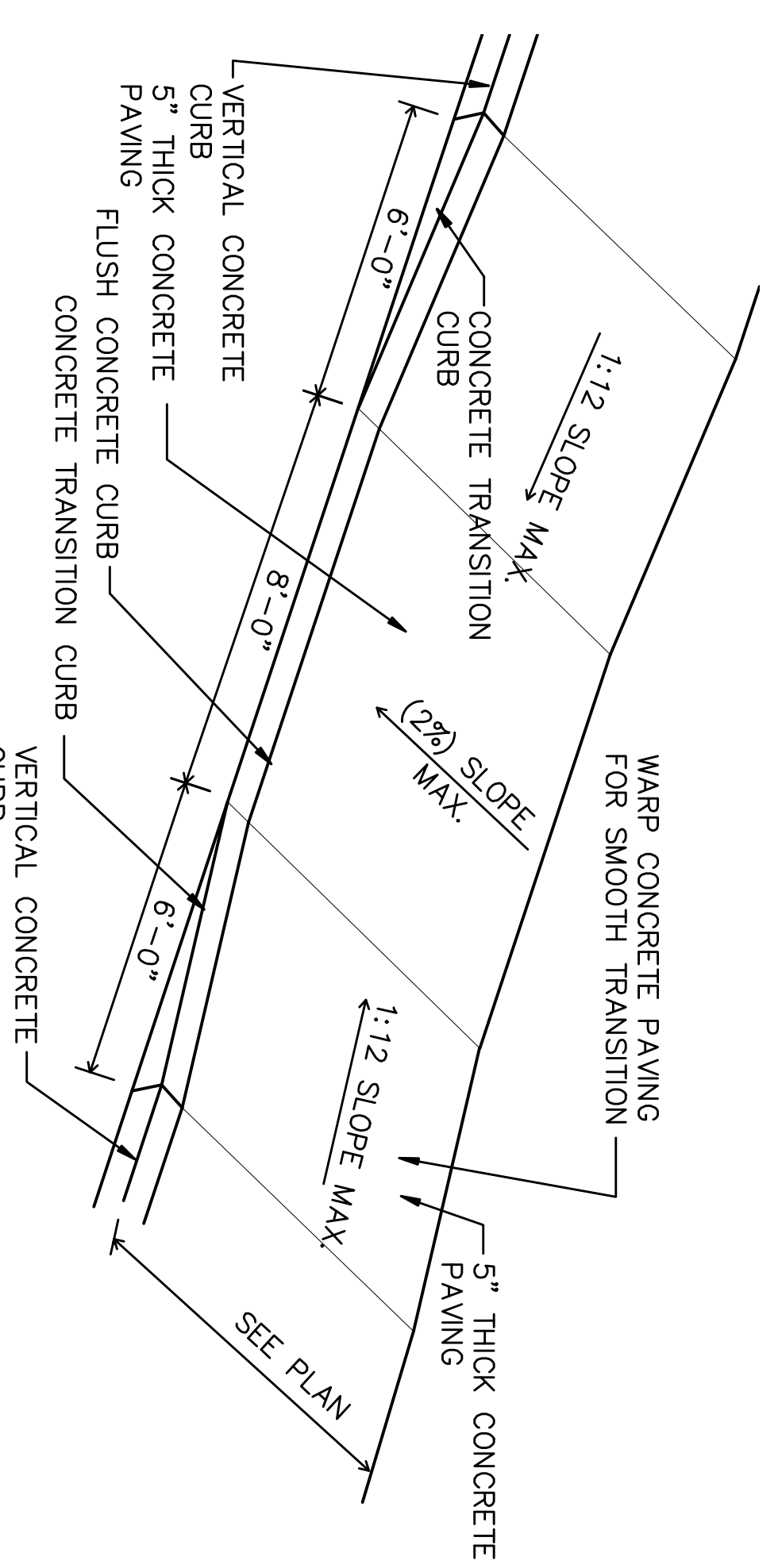

4 HANDICAP RAMP AT FIELD ENTRY GATE
SCALE: N15

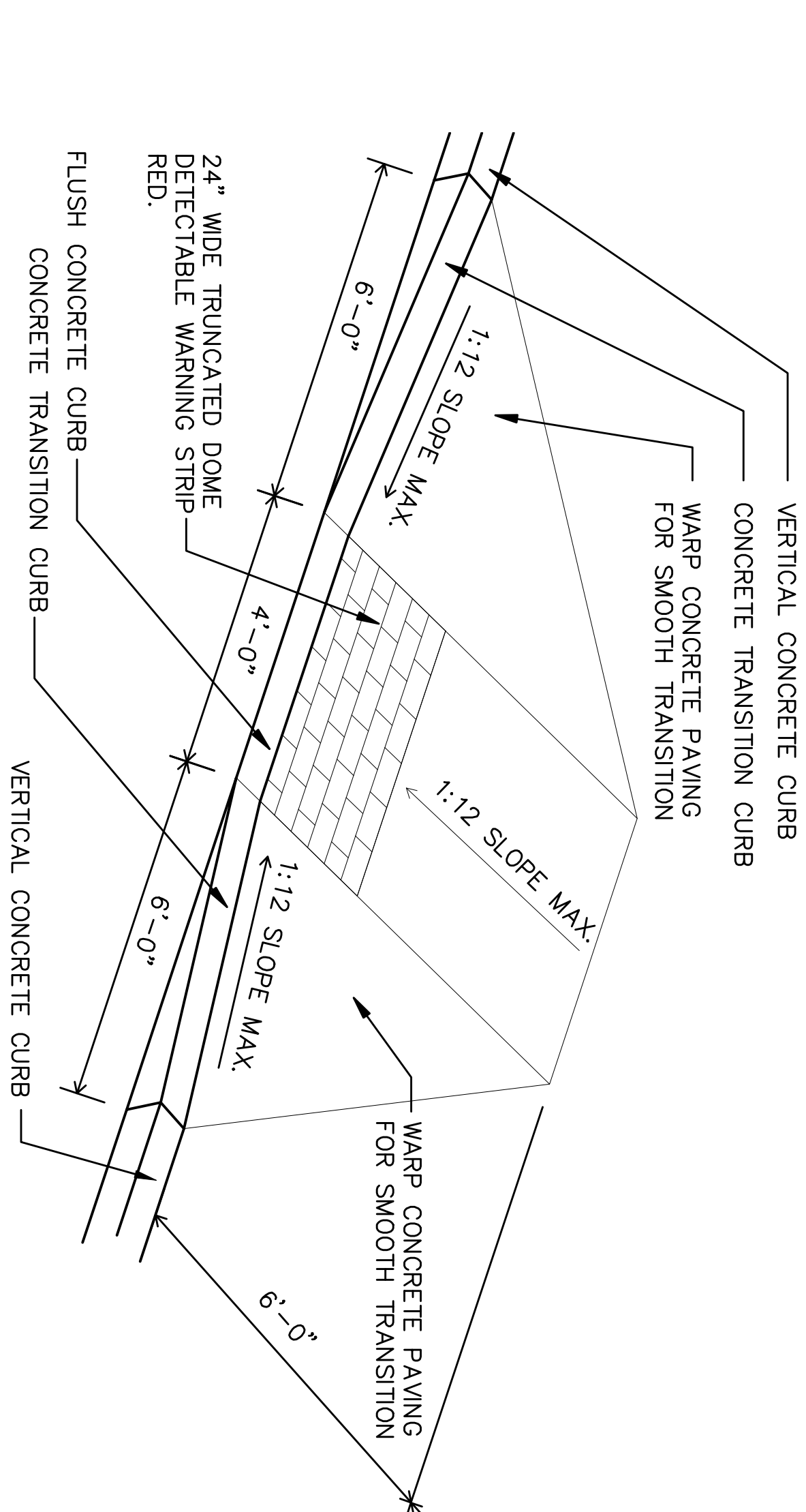

5 HANDICAP RAMP AT SUPPORT BUILDING
SCALE: N15

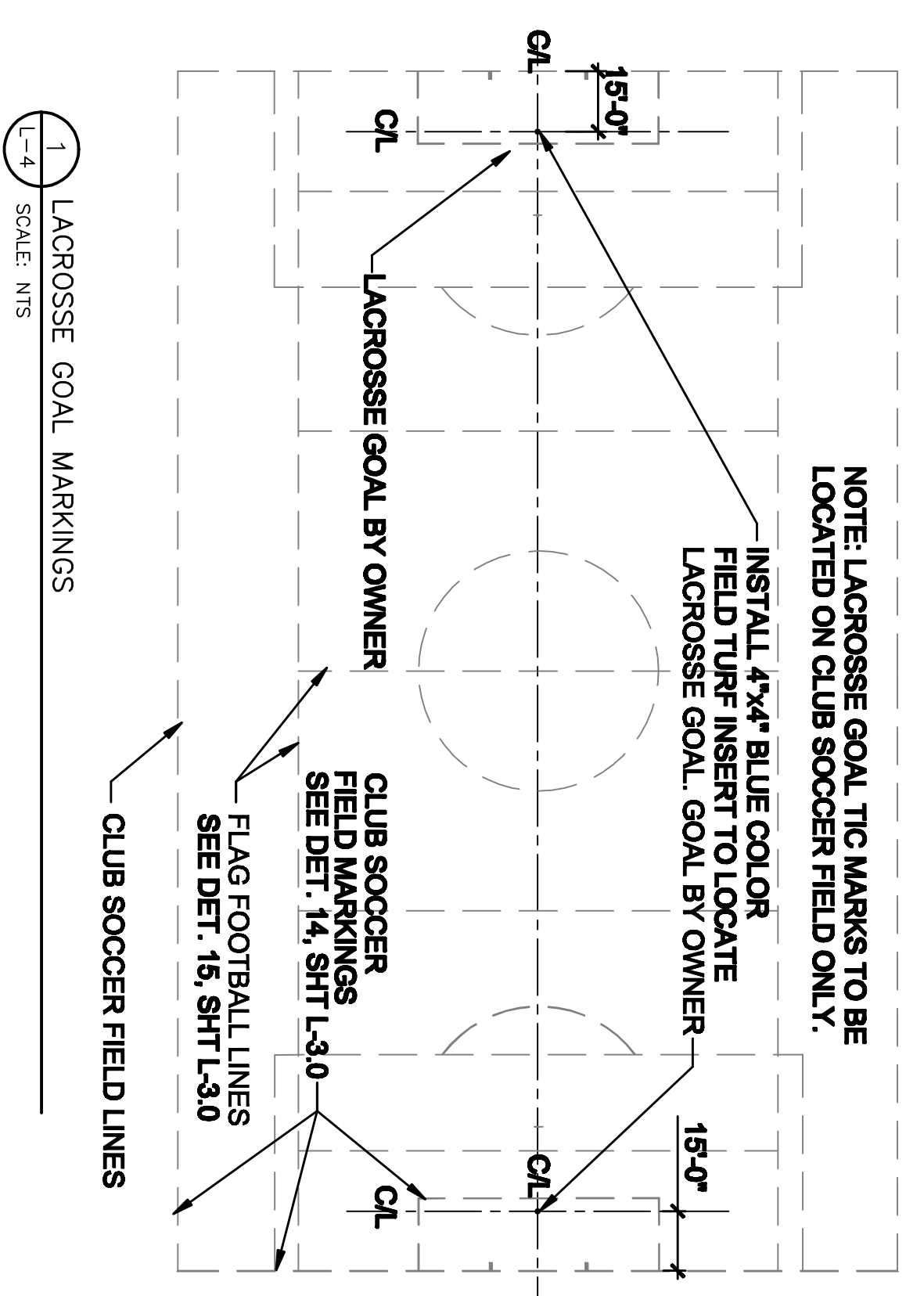

6 LACROSSE GOAL MARKINGS
SCALE: N15

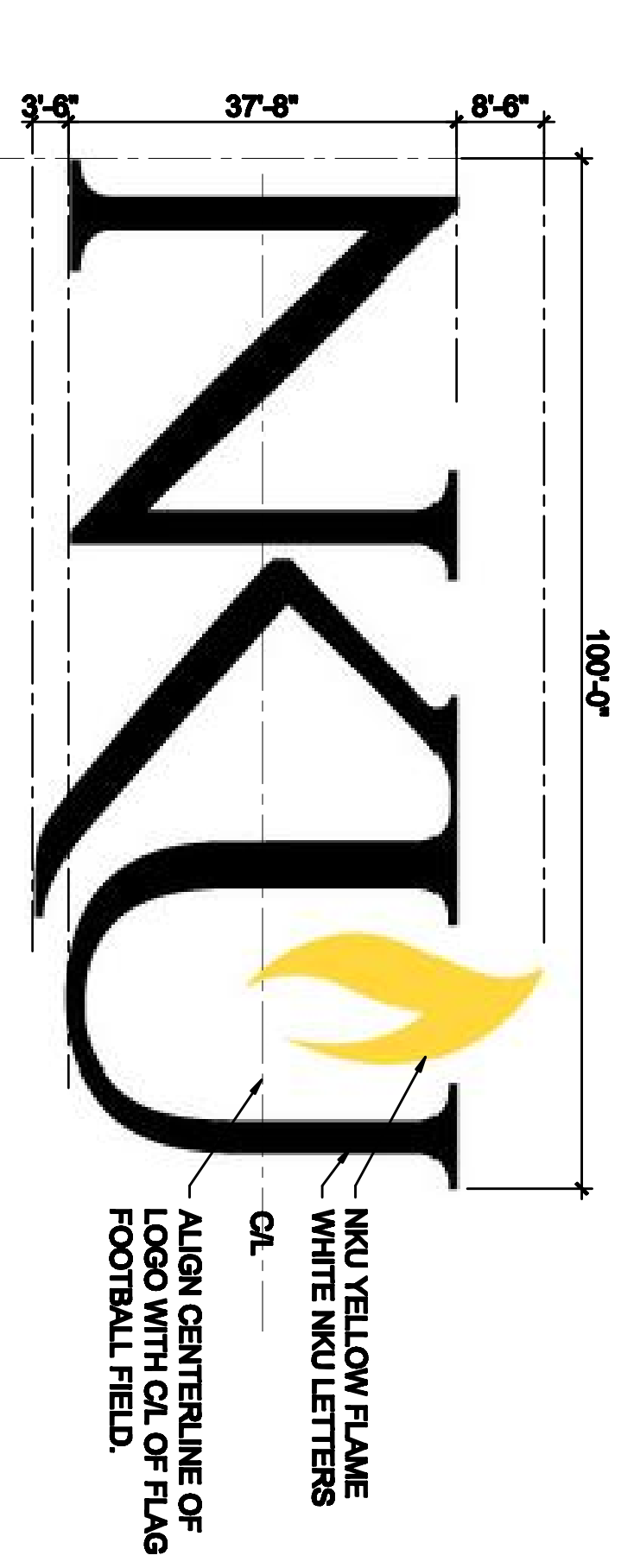

7 NKU FIELD LOGOS
SCALE: N15

- NOTES:
1. LOGO GRAPHICS FILE WILL BE PROVIDED BY NORTHERN KENTUCKY UNIVERSITY.
 2. LOGOS TO BE PERMANENTLY INSTALLED IN THE SLURRY MADE OF COLORED FABRI-TEK GRANITE AND POLYURETHANE ADHESIVE. PROVIDE LOGO MOCKUP FOR OWNER APPROVAL PRIOR TO FABRICATION.



8 NKU FIELD LOGOS
SCALE: N15

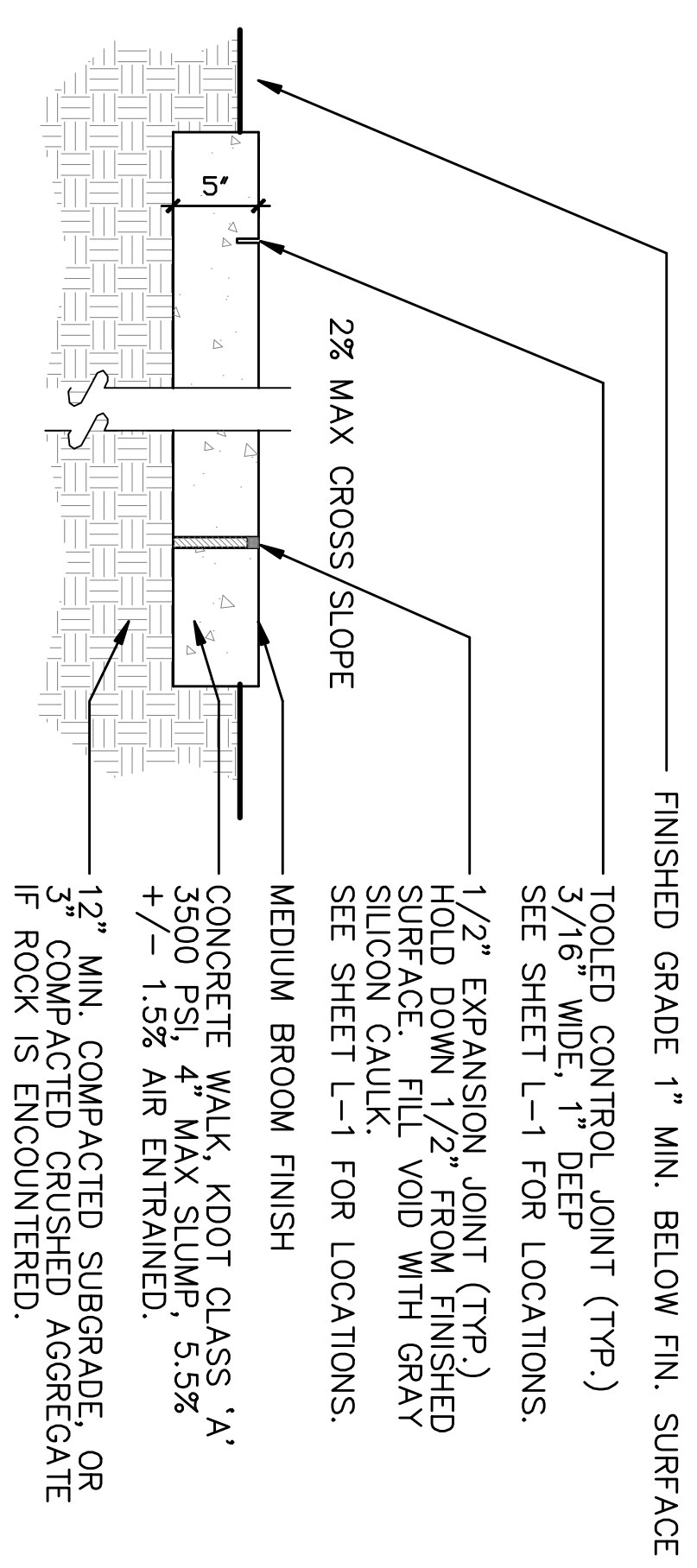

9 CONCRETE SIDEWALK DETAIL
SCALE: N15

10 NOT USED

11 NOT USED

BID SET

Northern Kentucky University - Intramural Fields & Support Building

Drawing Name:	Sheet Name:	#	Revision Date
Construction Details			
NKU Project Number:			
Project Number:	1203		
Date:	8/31/2012		
Drawn By:	FCB	Checked By:	TRW

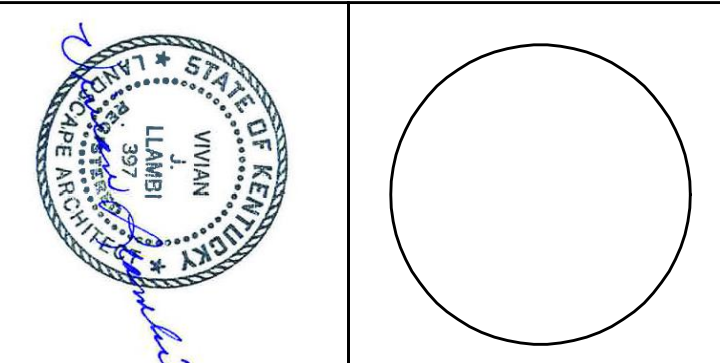

L-4.0